











Turko Automotive Parts

Turko Automotive Parts

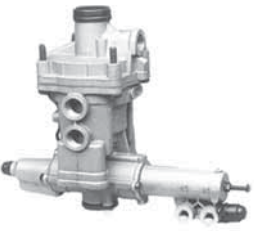









TAP

07
07
VOLVO

<p>Four Circuit Protection Valve</p> <p>TAP NO: 44.0101</p> <p>REF. NO: 934 702 320 0 OEM NO: 4871 098</p> 	<p>Trailer Control Valve</p> <p>TAP NO: 44.0102</p> <p>REF. NO: 973 002 000 0</p> 
<p>Relay Emergency Valve</p> <p>TAP NO: 44.0103</p> <p>REF. NO: 973 002 520 0</p> 	<p>Load Sensing Valve</p> <p>TAP NO: 44.0104</p> <p>REF. NO: 475 710 020 0</p> 
<p>Load Sensing Valve</p> <p>TAP NO: 44.0105</p> <p>REF. NO: 475 715 000 0</p> 	<p>Leveling Valve</p> <p>TAP NO: 44.0106</p> <p>REF. NO: 0 500 005 006 OEM NO: 367 838</p> 
<p>Leveling Valve</p> <p>TAP NO: 44.0107</p> <p>REF. NO: SV 1294</p> 	<p>Leveling Valve</p> <p>TAP NO: 44.0108</p> <p>REF. NO: SV 1295</p> 
<p>Leveling Valve</p> <p>TAP NO: 44.0109</p> <p>REF. NO: 464 006 000 0 OEM NO: 1607 728</p> 	<p>Adjusttable Quick Release Valve</p> <p>TAP NO: 44.0110</p> <p>REF. NO: 975 001 000 0 OEM NO: 352 097</p> <p>10 BAR M22x1,5</p> 

<p>Manuel Empty Valve</p> <p>TAP NO: 44.0111</p> <p>REF. NO: 475 604 010 0</p>  <p>20 BAR M22x1,5</p>	<p>Directional Valve</p> <p>TAP NO: 44.0112</p> <p>REF. NO: 463 036 000 0</p>  <p>10 BAR M10x1,5</p>
<p>Air Line Filter Valve</p> <p>TAP NO: 44.0113</p> <p>REF. NO: 432 500 020 0 OEM NO: 1591 031</p>  <p>20 BAR M22x1,5</p>	<p>Foot Valve</p> <p>TAP NO: 44.0114</p> <p>REF. NO: 461 315 008 0 OEM NO: 6996 123</p>  <p>10 BAR M16x1,5</p>
<p>Foot Valve</p> <p>TAP NO: 44.0115</p> <p>REF. NO: 461 315 012 0 OEM NO: 1696 150</p>  <p>10 BAR M16x1,5</p>	<p>Foot Valve</p> <p>TAP NO: 44.0116</p> <p>REF. NO: 461 319 008 0</p>  <p>10 BAR M16x1,5</p>
<p>Foot Valve</p> <p>TAP NO: 44.0117</p> <p>REF. NO: 461 307 479 0 OEM NO: 1696 150</p> 	<p>Hand Brake Valve</p> <p>TAP NO: 44.0118</p> <p>REF. NO: 961 701 100 0 OEM NO: 1132 026</p>  <p>8 BAR M14x1,5</p>
<p>Hand Brake Valve</p> <p>TAP NO: 44.0119</p> <p>REF. NO: APSA 5890</p> 	<p>Hand Brake Valve</p> <p>TAP NO: 44.0120</p> <p>REF. NO: 961 723 004 0 OEM NO: 6702 610</p> 

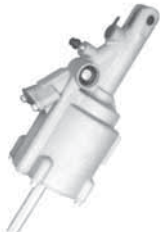
Hand Brake Valve	TAP NO: 44.0121 REF. NO: SV 3111	Hand Brake Valve	TAP NO: 44.0122 REF. NO: SV 3115
			
Unloader Valve	TAP NO: 44.0123 REF. NO: 975 300 502 0 OEM NO: 6789 355	Unloader Valve	TAP NO: 44.0124 REF. NO: 975 303 473 0 OEM NO: 6789 355
			
Unloader Valve	TAP NO: 44.0125 REF. NO: 975 303 060 0	Air Dryer Valve	TAP NO: 44.0126 REF. NO: 432 431 100 0
			
Governor Valve	TAP NO: 44.0127 REF. NO: 275 508	Clutch Servo Unit Valve	TAP NO: 44.0128 REF. NO: APGA 1605 IP
			
Clutch Servo Unit Valve	TAP NO: 44.0129 REF. NO: 626 392AM	Clutch Servo Unit Valve	TAP NO: 44.0130 REF. NO: 655 436AM
			

Clutch Servo Unit Valve

TAP NO: **44.0131**



REF. NO: **626639 AM**
 OEM NO: **1521 371**
1671 953

Pressure Regulator Valve

TAP NO: **44.0132**



REF. NO: **434 100 124 0**
 OEM NO: **1134 344**
7938 2131

Door Selenoid Valve

TAP NO: **44.0133**



REF. NO: **472 017 480 0**

Directional Valve

TAP NO: **44.0134**

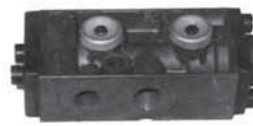

REF. NO: **0 501 208 629**

Gear Box Valve

TAP NO: **44.0135**



OEM NO: **3092 123**
1669 324

Gear Box Valve

TAP NO: **44.0136**



OEM NO: **1068 951**
1669 297

Relay Valve Rep. Kit

TAP NO: **44.0137**



REF. NO: **1 487 010 299**
 OEM NO: **3090 254**

Four Circuit Protection Rep. Kit

TAP NO: **44.0138**



REF. NO: **473 302 000 2**
 OEM NO: **272 797**

Trailer Control Valve Rep. Kit

TAP NO: **44.0139**

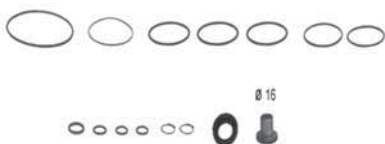

REF. NO: **1 487 010 166**

Load Sensing Valve Rep. Kit

TAP NO: **44.0140**



REF. NO: **475 715 000 2**

Levelling Valve Rep. Kit

TAP NO: 44.0141

REF. NO: 464 002 005 2
OEM NO: 273 668

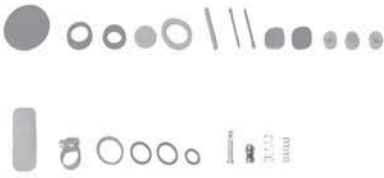

Manuel Empty Valve Rep. Kit

TAP NO: 44.0142

REF. NO: 475 604 002 2



Foot Valve Rep. Kit

TAP NO: 44.0143

REF. NO: 461 307 004 2

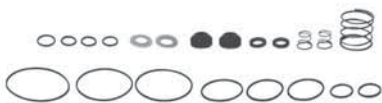

Hand Brake Valve Rep. Kit

TAP NO: 44.0144

REF. NO: 463 032 001 2



TristopSpring Brake Actuar Valve Rep. Kit

TAP NO: 44.0145

REF. NO: 925 320 001 2
OEM NO: 272 866



TristopSpring Brake Actuar Valve Rep. Kit

TAP NO: 44.0146

REF. NO: 925 320 002 2
OEM NO: 1697 222
227 884



Unloader Valve Rep. Kit

TAP NO: 44.0147

REF. NO: 1 487 010 164

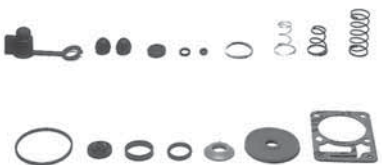

Air Dryer Unloader Valve Rep. Kit

TAP NO: 44.0148

REF. NO: 432 431 000 2



Clutch Servo Unit Valve Rep. Kit

TAP NO: 44.0149

REF. NO: GA 29317
OEM NO: 273 632



Automatic Drain Valve Rep. Kit

TAP NO: 44.0150

REF. NO: 434 300 000 2



Clutch Servo Unit Valve Rep. Kit TAP NO: 44.0151

REF. NO: GA 292 83



Clutch Servo Unit Valve Rep. Kit TAP NO: 44.0152

REF. NO: 626703 AM

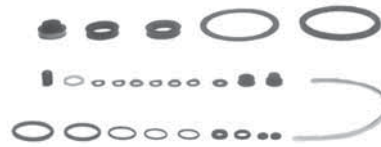

Clutch Servo Unit Valve Rep. Kit TAP NO: 44.0153

REF. NO: 622158 AM

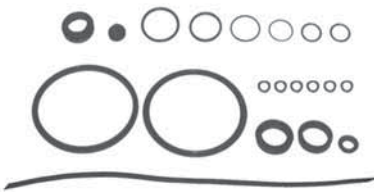

Hydraulic Clutch Unit Valve Rep. Kit TAP NO: 44.0154

REF. NO: RK 2866
OEM NO: 273 660



Pressure Regulator Valve Rep. Kit TAP NO: 44.0155

REF. NO: 434 100 009 2



Pressure Regulator Valve Rep. Kit TAP NO: 44.0156

REF. NO: 434 100 002 2

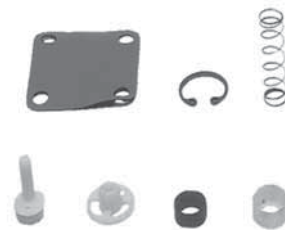

Pressure Regulator Valve Rep. Kit TAP NO: 44.0157

REF. NO: 1 487 010 221



Pressure Regulator Valve Rep. Kit TAP NO: 44.0158

REF. NO: 434 100 000 2



Directional Control Valve Rep. Kit TAP NO: 44.0159

REF. NO: 571 003 002 2
OEM NO: 273 666



Air Brake Compressor TAP NO: 44.0160

OEM NO: 1599 999
5003 217



Ø75mm 440 cc Stroke: 50mm

Air Compressor Twin Cylinder

TAP NO: **44.0161**



OEM NO: **8112 594**
1628 593

Ø88mm 600 cc Stroke: 50mm

Air Compressor Twin Cylinder

TAP NO: **44.0162**



OEM NO: **3173 001**
5000 066

Ø88mm 600 cc Stroke: 50mm

Air Compressor Twin Cylinder

TAP NO: **44.0163**



OEM NO: **9521 675**
8113 023

Ø88mm 600 cc Stroke: 50mm

Air Compressor Twin Cylinder

TAP NO: **44.0164**



OEM NO: **8112 594**
1628593

Ø88mm 600 cc Stroke: 50mm

Air Compressor Twin Cylinder

TAP NO: **44.0165**



OEM NO: **8129 779**

Ø88mm 600 cc Stroke: 50mm

Air Compressor Twin Cylinder

TAP NO: **44.0166**



OEM NO: **8113 633**
7 0305 889

Ø88mm 600 cc Stroke: 50mm

Air Compressor Twin Cylinder

TAP NO: **44.0167**



OEM NO: **3118 286**
8112 821

Ø88mm 600 cc Stroke: 50mm

Air Compressor Twin Cylinder

TAP NO: **44.0168**



OEM NO: **9521 897**
8113 053

Ø88mm 600 cc Stroke: 50mm

Air Compressor Twin Cylinder

TAP NO: **44.0169**



OEM NO: **8113 815**
7 0305 890

Ø88mm 600 cc Stroke: 50mm

Air Compressor

TAP NO: **44.0170**



OEM NO: **8113 634**
7 0305892

Ø88mm 600 cc Stroke: 50mm

Air Brake Compressor

TAP NO: 44.0171

OEM NO: 8129 779



2xØ75mm 440 cc Stroke: 50mm

Air Compressor

TAP NO: 44.0172

OEM NO: 2 0382 348
MODEL: FH



Ø88mm 352 cc Stroke: 62mm

Air Compressor Twin Cylinder

TAP NO: 44.0173

OEM NO: 2 0701 801
MODEL: FH12
FH16



Ø85mm 700 cc Stroke: 62mm

Air Brake Compressor Twin Cylinder

TAP NO: 44.0174

REF. NO: 911 505 150 0
OEM NO: 1626 060
5003 460



2xØ85 704 cc Stroke: 62mm

Air Brake Compressor Twin Cylinder

TAP NO: 44.0175

OEM NO: 8112 426
3037 344



Ø85mm 704 cc Stroke: 62mm

Air Brake Compressor

TAP NO: 44.0176

OEM NO: 1613 632



Ø75mm 440 cc Stroke: 50mm

Compressor

TAP NO: 44.0177

OEM NO: 1080 437
1612 335
MODEL: FL7 10
F10 12
16



Compressor

TAP NO: 44.0178

OEM NO: 8150 407
MODEL: F10 F12



Cylinder Head Complete

TAP NO: 44.0179

OEM NO: -











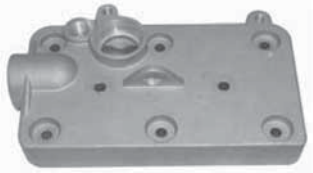

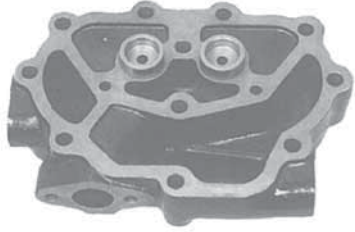









Cylinder Head

TAP NO: 44.0180

OEM NO: 3090 472



<p>Cylinder Head</p> <p>TAP NO: 44.0181</p> <p>OEM NO: 2038 2347</p> 	<p>Cylinder Head</p> <p>TAP NO: 44.0182</p> <p>OEM NO: -</p> 
<p>Compressor Cylinder Head</p> <p>TAP NO: 44.0183</p> <p>OEM NO: 1695 153 3090 472</p> <p>MODEL: FL7 10 F10 12 16</p> 	<p>Compressor Cylinder Head</p> <p>TAP NO: 44.0184</p> <p>OEM NO: 1518 372</p> <p>MODEL: FL7 10 F10 12 16</p> 
<p>Compressor Cylinder Head</p> <p>TAP NO: 44.0185</p> <p>OEM NO: 3090 4736</p> <p>MODEL: FL7 10 F10 12 16</p> 	<p>Cylinder Head</p> <p>TAP NO: 44.0186</p> <p>OEM NO: -</p> 
<p>Cylinder Head</p> <p>TAP NO: 44.0187</p> <p>OEM NO: -</p> 	<p>Compressor Crank Shaft</p> <p>TAP NO: 44.0188</p> <p>OEM NO: 1518 353</p> 
<p>Compressor Piston With Ring</p> <p>TAP NO: 44.0189</p> <p>OEM NO: 3090 257 1518 356</p> 	<p>Compressor Connecting Rod</p> <p>TAP NO: 44.0190</p> <p>OEM NO: 3090 386</p> 

<p>Compressor Piston With Ring TAP NO: 44.0191</p> <p>OEM NO: 3094 152 1697 707</p>  <p>Ø75mm 0,10</p>	<p>Compressor Piston Without Ring TAP NO: 44.0192</p> <p>OEM NO: 1697 477</p> 
<p>Compressor Piston With Ring TAP NO: 44.0193</p> <p>OEM NO: 3094 153 1697 708</p>  <p>Ø75mm 0,20</p>	<p>Compressor Piston Without Ring TAP NO: 44.0194</p> <p>OEM NO: 1697 479</p>  <p>Ø63.5mm 0,20</p>
<p>Compressor Piston Without Ring TAP NO: 44.0195</p> <p>OEM NO: 1697 478</p> 	<p>Compressor Piston TAP NO: 44.0196</p> <p>OEM NO: 1698 686</p>  <p>Ø85mm STD</p>
<p>Compressor Cover TAP NO: 44.0197</p> <p>OEM NO: 1698 674</p> 	<p>Compressor Cover TAP NO: 44.0198</p> <p>OEM NO: 3090 385</p> 
<p>Compressor Piston Ring Set TAP NO: 44.0199</p> <p>OEM NO: 3094 155 272 896</p>  <p>Ø75mm STD</p>	<p>Compressor Piston Ring Set TAP NO: 44.0200</p> <p>OEM NO: 3094 156 270 613</p>  <p>Ø75mm 0,10</p>

Compressor Piston Ring Set

TAP NO: 44.0201

OEM NO: 3094 157
270 615



Ø75mm 0,20

Compressor Piston Ring Set

TAP NO: 44.0202

OEM NO: 328 752

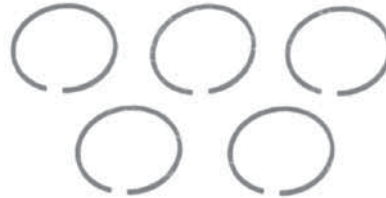

Ø63.5mm STD

Compressor Piston Ring Set

TAP NO: 44.0203

OEM NO: 328 753

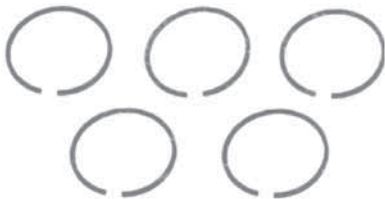

Ø63.5mm 0,10

Compressor Piston Ring Set

TAP NO: 44.0204

OEM NO: 328 754

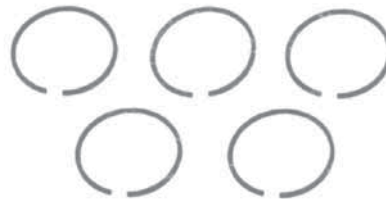

Ø63.5mm 0,20

Compressor Valve Plate

TAP NO: 44.0205

OEM NO: 3090 380

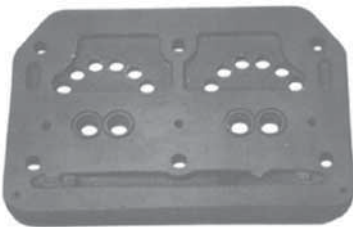

Compressor Gasket Kit

TAP NO: 44.0206

OEM NO: 3090 377

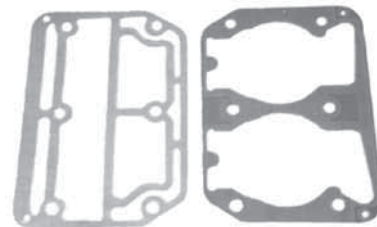

Compressor Rep. Kit

TAP NO: 44.0207

OEM NO: 8113 829



80mm

Compressor Rep. Kit

TAP NO: 44.0208

OEM NO: 8150 407

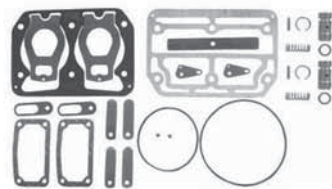

75mm

Compressor Rep. Kit

TAP NO: 44.0209

OEM NO: 2 0382 347
MODEL: FH12 FM12

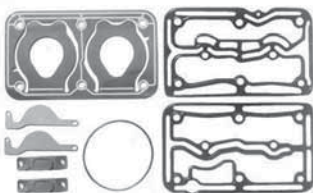

85mm



Compressor Rep. Kit







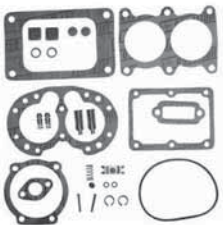
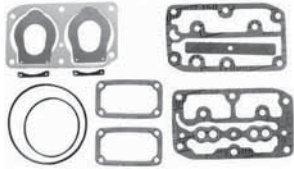
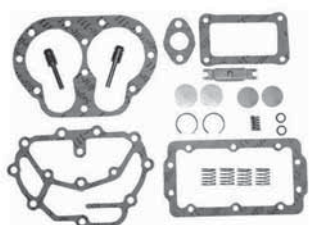
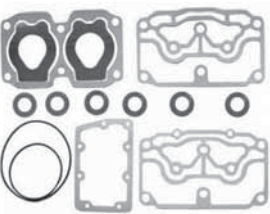
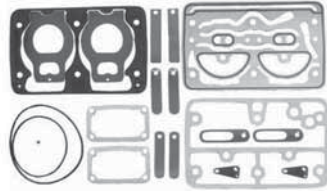
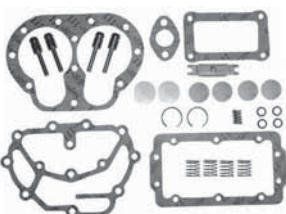
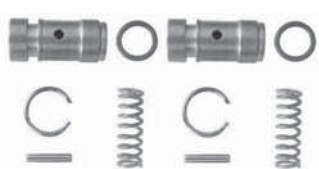

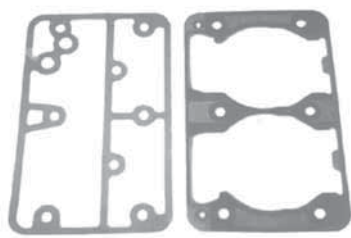
TAP NO: 44.0210



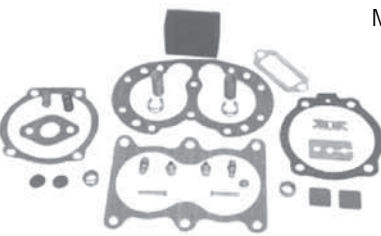
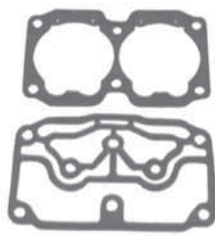

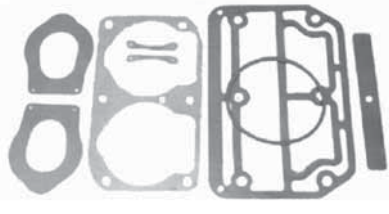
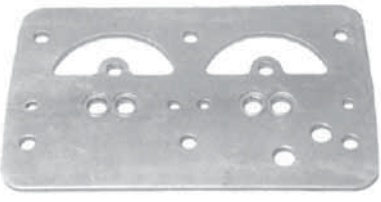



OEM NO: 2 0382 348
MODEL: FH12 FM12







85mm

<p>Compressor Rep. Kit</p> <p>TAP NO: 44.0211</p> <p>OEM NO: 1320 401 MODEL: FH12 FH16</p>  <p>88mm</p>	<p>Compressor Rep. Kit</p> <p>TAP NO: 44.0212</p> <p>OEM NO: 1599 919</p> 
<p>Compressor Rep. Kit</p> <p>TAP NO: 44.0213</p> <p>OEM NO: -</p>  <p>75mm</p>	<p>Compressor Rep. Kit</p> <p>TAP NO: 44.0214</p> <p>OEM NO: 1612 335</p>  <p>75mm</p>
<p>Compressor Rep. Kit</p> <p>TAP NO: 44.0215</p> <p>OEM NO: 1626 060 MODEL: F10 F12 F16 FL7</p>  <p>85mm</p>	<p>Compressor Rep. Kit</p> <p>TAP NO: 44.0216</p> <p>OEM NO: 1628 593 MODEL: FH12</p>  <p>88mm</p>
<p>Compressor Rep. Kit</p> <p>TAP NO: 44.0217</p> <p>OEM NO: 3090 471</p>  <p>75mm</p>	<p>Compressor Rep. Kit</p> <p>TAP NO: 44.0218</p> <p>OEM NO: 3097 147</p> 
<p>Compressor Rep. Kit</p> <p>TAP NO: 44.0219</p> <p>OEM NO: 2 0429 341 MODEL: F12 FM12 NH12</p>  <p>88mm</p>	<p>Compressor Gasket Kit</p> <p>TAP NO: 44.0220</p> <p>OEM NO: 3097 143</p> 

<p>Compressor Repair Kit</p> <p>TAP NO: 44.0221</p> <p>OEM NO: 3090 471</p> 	<p>Compressor Repair Kit</p> <p>TAP NO: 44.0222</p> <p>OEM NO: 270 698</p> 
<p>Compressor Repair Kit</p> <p>TAP NO: 44.0223</p> <p>OEM NO: 272 813</p> <p>MODEL: F86 87 88 89</p> <p>FB86 88</p> 	<p>Compressor Gasket Set</p> <p>TAP NO: 44.0224</p> <p>OEM NO: 138 021</p> <p>276 183</p> 
<p>Compressor Valve Set</p> <p>TAP NO: 44.0225</p> <p>OEM NO: 138 022</p> <p>1698 683</p> 	<p>Compressor Repair Kit</p> <p>TAP NO: 44.0226</p> <p>OEM NO: 270879</p> 
<p>Compressor Valve Body</p> <p>TAP NO: 44.0227</p> <p>OEM NO: 3097 146</p> 	<p>Flywheel</p> <p>TAP NO: 44.0228</p> <p>OEM NO: 478 913</p>  <p>Ø430mm</p>
<p>Flywheel</p> <p>TAP NO: 44.0229</p> <p>OEM NO: 422 740</p> <p>MODEL: F10</p>  <p>Ø430mm</p>	<p>Flywheel</p> <p>TAP NO: 44.0230</p> <p>OEM NO: 422 746</p> <p>MODEL: F12</p>  <p>Ø430mm</p>

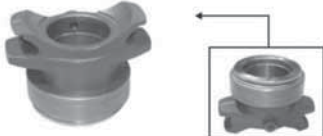
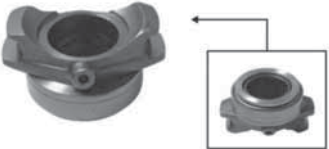
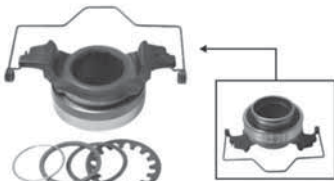
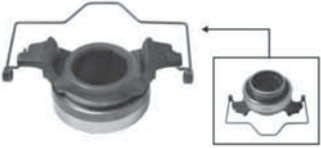
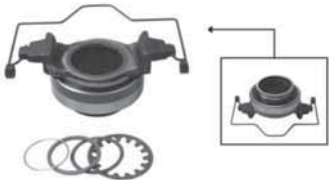
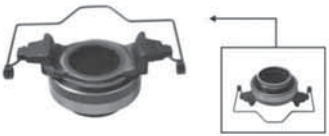
<p>Flywheel</p> <p>TAP NO: 44.0231</p> <p>OEM NO: 2 0729 327 MODEL: NH12 FM12 FH12</p>  <p>Ø430mm</p>	<p>Flywheel</p> <p>TAP NO: 44.0232</p> <p>OEM NO: 478 931</p>  <p>Ø430mm</p>
<p>Flywheel</p> <p>TAP NO: 44.0233</p> <p>OEM NO: 479 543 479 192</p>  <p>Ø430mm</p>	<p>Flywheel</p> <p>TAP NO: 44.0234</p> <p>OEM NO: 1547 025</p>  <p>Ø380mm</p>
<p>Ring Gear</p> <p>TAP NO: 44.0235</p> <p>OEM NO: 420 314</p> 	<p>Ring Gear</p> <p>TAP NO: 44.0236</p> <p>OEM NO: 471 532 MODEL: FH12</p> 
<p>Ring Gear</p> <p>TAP NO: 44.0237</p> <p>OEM NO: 420 794 423 082 MODEL: F10 F12 FL10 N10</p> 	<p>Flywheel Housing</p> <p>TAP NO: 44.0238</p> <p>REF. NO: 468 554 468 553 479 477</p> 
<p>Gear Box Housing</p> <p>TAP NO: 44.0239</p> <p>REF. NO: -</p> 	<p>Turbo</p> <p>TAP NO: 44.0240</p> <p>REF. NO: 422 856 422 934 MODEL: FL10 102 FS E TD102 103 9.1 L</p> 

<p>Turbo</p> <p>TAP NO: 44.0241</p> <p>OEM NO: 42503 0 8113 009</p> 	<p>Turbo</p> <p>TAP NO: 44.0242</p> <p>REF. NO: 1545 098</p> 
<p>Turbo</p> <p>TAP NO: 44.0243</p> <p>REF. NO: 468 931 3528 320 MODEL: F12 N12 12L TD120C D</p> 	<p>Release Bearing</p> <p>TAP NO: 44.0244</p> <p>OEM NO: 1527 695</p> 
<p>Release Bearing</p> <p>TAP NO: 44.0245</p> <p>OEM NO: 1527 693 MODEL: F7</p> 	<p>Release Bearing</p> <p>TAP NO: 44.0246</p> <p>OEM NO: 1655 732 MODEL: FM9 FM7 FM12 FH12</p> 
<p>Release Bearing</p> <p>TAP NO: 44.0247</p> <p>OEM NO: 1672 847</p> 	<p>Release Bearing</p> <p>TAP NO: 44.0248</p> <p>OEM NO: 1655 843 MODEL: FM9 FM12 FL10 FH16 FH12</p> 
<p>Release Bearing</p> <p>TAP NO: 44.0249</p> <p>OEM NO: 1672 945</p> 	<p>Release Bearing</p> <p>TAP NO: 44.0250</p> <p>OEM NO: 1655 829 MODEL: FM9 FM12 FL12</p> 

Release Bearing

TAP NO: 44.0251

OEM NO: 1672 847



Release Bearing

TAP NO: 44.0252

OEM NO: 1655 843
MODEL: FH12 FH16
FL10 FL12

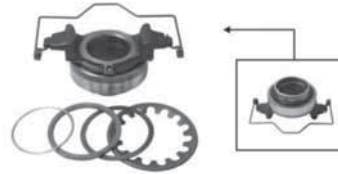

Release Bearing

TAP NO: 44.0253

OEM NO: 1672 945



Spring Brace

TAP NO: 44.0254

OEM NO: 1655 135



Release Bearing

TAP NO: 44.0255

OEM NO: 2 0366 913

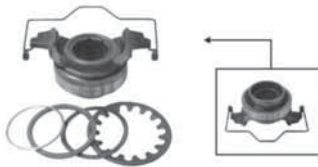

Release Bearing

TAP NO: 44.0256

OEM NO: 3192 227



Release Bearing With Oil

TAP NO: 44.0257

OEM NO: 1655 732
MODEL: FM9 FM7
FM12

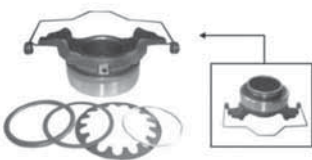

Release Bearing

TAP NO: 44.0258

OEM NO: 3192 225

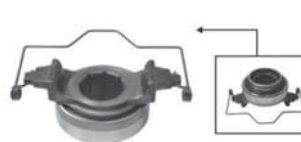

Release Bearing

TAP NO: 44.0259

REF. NO: 3192 220
MODEL: FH12 FM12
FM7











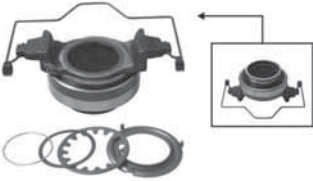
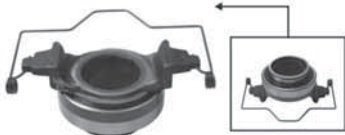
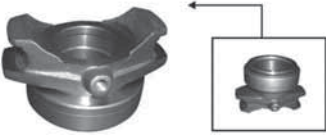

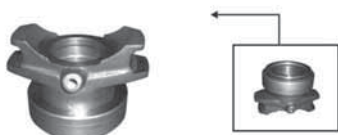

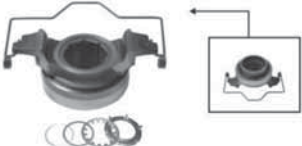
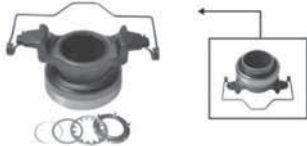
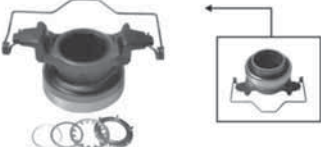



Clutch Release Bearing

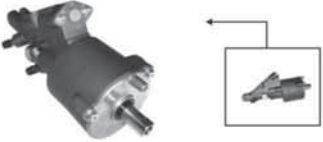









TAP NO: 44.0260

OEM NO: 3192 216
MODEL: FH12 FL10
FL12 FM12
FM7



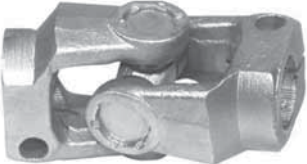









<p>Clutch Release Bearing</p> <p>TAP NO: 44.0261</p> <p>OEM NO: 3192 218 MODEL: FH12 FM12 FM9</p> 	<p>Clutch Release Bearing</p> <p>TAP NO: 44.0262</p> <p>OEM NO: 3192 219</p> 
<p>Clutch Release Bearing</p> <p>TAP NO: 44.0263</p> <p>OEM NO: 1655 288 MODEL: FL6</p> 	<p>Clutch Release Bearing</p> <p>TAP NO: 44.0264</p> <p>OEM NO: 165 5287 MODEL: FL6</p> 
<p>Clutch Release Bearing</p> <p>TAP NO: 44.0265</p> <p>OEM NO: 6797 058 MODEL: FL6</p> 	<p>Clutch Release Bearing</p> <p>TAP NO: 44.0266</p> <p>OEM NO: 2 0569 153 MODEL: FM7 FM12 FM10 FL12</p> 
<p>Clutch Release Bearing</p> <p>TAP NO: 44.0267</p> <p>OEM NO: 2 0366 913</p> 	<p>Clutch Release Bearing</p> <p>TAP NO: 44.0268</p> <p>OEM NO: 2 0366 912</p> 
<p>Clutch Release Bearing</p> <p>TAP NO: 44.0269</p> <p>OEM NO: 2 0569 155</p> 	<p>Clutch Master Cylinder</p> <p>TAP NO: 44.0270</p> <p>OEM NO: 1620 462 MODEL: N10 FL7 FL10 F12</p> 

<p>Clutch Master Cylinder Repair Kit TAP NO: 44.0271</p> <p>OEM NO: 271 106 MODEL: NH12 N10 FH16 FH12 FL10</p> 	<p>Clutch Master Cylinder Repair Kit TAP NO: 44.0272</p> <p>OEM NO: 3094 730 MODEL: NH12 N10 FH16 FH12 FL10</p> 
<p>Clutch Servo TAP NO: 44.0273</p> <p>OEM NO: 1655 639 MODEL: F10 F12 FL6 FL7</p> 	<p>Clutch Servo Repair Kit TAP NO: 44.0274</p> <p>OEM NO: 271 194 MODEL: FL6 FL7 FL10</p> 
<p>Clutch Master Cylinder Repair Kit TAP NO: 44.0275</p> <p>OEM NO: 273 660 MODEL: F10 F12 FH12 FH16</p> 	<p>Clutch TAP NO: 44.0276</p> <p>OEM NO: 8172 824 MODEL: FH12 FH16 FM12</p> 
<p>Clutch Release Bearing Lever TAP NO: 44.0277</p> <p>OEM NO: 3192 250</p> 	<p>Clutch Release Bearing Lever TAP NO: 44.0278</p> <p>OEM NO: -</p> 
<p>King Pin Set TAP NO: 44.0279</p> <p>OEM NO: 2 0751 021 MODEL: FL6</p> 	<p>Clutch Release Bearing Repair Kit TAP NO: 44.0280</p> <p>OEM NO: 2 0751 021 MODEL: FL6</p> 

<p>Door Handle</p> <p>TAP NO: 44.0281</p> <p>OEM NO: 664 3673</p> 	<p>Plu Cylinder Head</p> <p>TAP NO: 44.0282</p> <p>OEM NO: 467 365</p> 
<p>Ball Stud.</p> <p>TAP NO: 44.0283</p> <p>OEM NO: 422 993</p> 	<p>Repair Kit For Axle Rod arm Center</p> <p>TAP NO: 44.0284</p> <p>OEM NO: 0273 706</p> 
<p>Intermediate Flange Assy</p> <p>TAP NO: 44.0285</p> <p>OEM NO: 5051 248</p> 	<p>Plate Compressor</p> <p>TAP NO: 44.0286</p> <p>OEM NO: 1518 372</p> 
<p>Universal Joint</p> <p>TAP NO: 44.0287</p> <p>OEM NO: 1606 502</p> 	<p>Hollow Spring</p> <p>TAP NO: 44.0288</p> <p>OEM NO: 1134 566</p> <p>MODEL : F10 F12</p> <p>F16 FL10</p> 
<p>Exh. Hose</p> <p>TAP NO: 44.0289</p> <p>OEM NO: 1078 111</p> 	<p>Exh. Hose</p> <p>TAP NO: 44.0290</p> <p>OEM NO: 1078 110</p> 

<p>Exh. Hose</p> <p>TAP NO: 44.0291</p> <p>OEM NO: 1078 119</p> 	<p>Flex. Hose</p> <p>TAP NO: 44.0292</p> <p>OEM NO: 1078 116</p> 
<p>Clamp</p> <p>TAP NO: 44.0293</p> <p>OEM NO: 8156 156</p> 	<p>Clutch Cylinder</p> <p>TAP NO: 44.0294</p> <p>OEM NO: 2 0835 246 2 0553 5588</p> <p>MODEL: NH12 FH12 FM9</p> 
<p>Clutch Cylinder</p> <p>TAP NO: 44.0295</p> <p>OEM NO: -</p> 	<p>Clutch Cylinder</p> <p>TAP NO: 44.0296</p> <p>OEM NO: 1 628 218</p> <p>MODEL: NH12 FM12 FH16</p> 
<p>Repair Kit</p> <p>TAP NO: 44.0297</p> <p>OEM NO: -</p> 	<p>Release Lever</p> <p>TAP NO: 44.0298</p> <p>OEM NO: 276 149 382 873 347 211</p> <p>MODEL: F10 F12</p> 
<p>Release Ring</p> <p>TAP NO: 44.0299</p> <p>OEM NO: 267 144</p> <p>MODEL: F10</p> 	<p>Release Ring</p> <p>TAP NO: 44.0300</p> <p>OEM NO: 356 878</p> 

<p>Release Lever Nut and Pin</p> <p>TAP NO: 44.0301</p> <p>OEM NO: - MODEL: F10</p> 	<p>Release Lever Repair Kit</p> <p>TAP NO: 44.0302</p> <p>OEM NO: - MODEL: F12</p> 
<p>Release Lever Nut and Pin</p> <p>TAP NO: 44.0303</p> <p>OEM NO: - MODEL: F12</p> 	<p>Release Lever Repair Kit</p> <p>TAP NO: 44.0304</p> <p>OEM NO: - MODEL: F10</p> 
<p>Brake Disc</p> <p>TAP NO: 44.0305</p> <p>OEM NO: 3092 710</p> 	<p>Brake Disc</p> <p>TAP NO: 44.0306</p> <p>OEM NO: 8510 3803</p> 
<p>Brake Disc</p> <p>TAP NO: 44.0307</p> <p>OEM NO: 8510 384</p> 	<p>Brake Drum</p> <p>TAP NO: 44.0308</p> <p>OEM NO: 1075 319</p> 
<p>Brake Drum</p> <p>TAP NO: 44.0309</p> <p>OEM NO: 1599 009 MODEL: FM9 FM7 FM12 FL7 FL10 FH16 FH12</p> 	<p>Brake Drum</p> <p>TAP NO: 44.0310</p> <p>OEM NO: 1599 011 MODEL: FM9 FM7 FM12 FL7 FL12 FL10</p> 

Brake Drum	TAP NO: 44.0311	Brake Drum	TAP NO: 44.0312
	OEM NO: 1599 012 MODEL: FL7 FL12 FL10 FH16 FH12		OEM NO: 1599 968
Brake Drum	TAP NO: 44.0313	Brake Drum	TAP NO: 44.0314
	OEM NO: 366 866		OEM NO: 1075 309
Brake Drum	TAP NO: 44.0315	Slack Adjuster	TAP NO: 44.0316
	OEM NO: 1075 311 MODEL: FM9 FM7 FM12 FL6 FL10 FH16 FH12		OEM NO: 2 1227 325
Slack Adjuster	TAP NO: 44.0317	Slack Adjuster	TAP NO: 44.0318
	OEM NO: 1136 432		OEM NO: 1136 433
Slack Adjuster	TAP NO: 44.0319	Slack Adjuster	TAP NO: 44.0320
	OEM NO: 1581 466		OEM NO: 1586 190

Slack Adjuster	TAP NO: 44.0321 OEM NO: 1586 191	Slack Adjuster	TAP NO: 44.0322 OEM NO: 1586 192
Slack Adjuster	TAP NO: 44.0323 OEM NO: 1586 193	Slack Adjuster	TAP NO: 44.0324 OEM NO: 1586 194
Slack Adjuster	TAP NO: 44.0325 OEM NO: 1590 239	Slack Adjuster	TAP NO: 44.0326 OEM NO: 3193 400
Slack Adjuster	TAP NO: 44.0327 OEM NO: 3193 401	V-Stay	TAP NO: 44.0328 OEM NO: 2 0556 490 3173 291 MODEL: FH12 FH16 NH12 FM Series
V-Stay	TAP NO: 44.0329 OEM NO: 2 1295 227 MODEL: FH FM	V-Stay	TAP NO: 44.0330 OEM NO: 2 0428 251 2 0491 771 MODEL: FH12 FH16 FM9 FM12

V-Stay

TAP NO: 44.0331



OEM NO: 1080 690
1606 200
MODEL: F10 F12
F16 FL12
FL07 N10

Torque Rod

TAP NO: 44.0332



OEM NO: 2105 052
MODEL: FH12 FH16
FH400 H440
FL6 FM12
FM9 FM380
FM400 FM
440 FM480

Drag Link Assy.

TAP NO: 44.0333



OEM NO: 1083 744
MODEL: F10 F12
F16

Trio Rod Assy.

TAP NO: 44.0334



OEM NO: 1194 824
1626 672
MODEL: FL10/360
10/320
FL 12

Drag Link Assy.

TAP NO: 44.0335



OEM NO: 2 0400 941
6790 572
MODEL: FL6 FL612/614

Drag Link Assy.

TAP NO: 44.0336



OEM NO: 1629 397
2 0393 075
MODEL: FH12 FH16
FM7 FM10

Drag Link Assy.

TAP NO: 44.0337

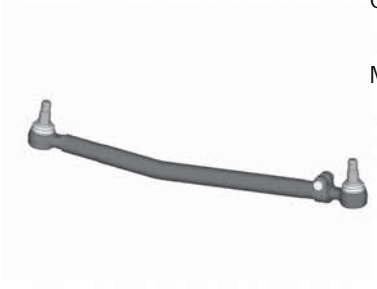

OEM NO: 1576 093
1606 284
MODEL: F10 F12
F16

Trio Rod Assy.

TAP NO: 44.0338



OEM NO: 1505 855
1606 274
MODEL: F10 F12
F16 F7
FL6 FL10
FL12

Drag Link Assy.

TAP NO: 44.0339



OEM NO: 1075 005
MODEL: FH12 FH16

Drag Link Assy.

TAP NO: 44.0340

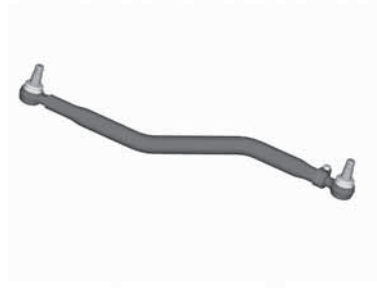

OEM NO: 1592 940
MODEL: FL7 FL10
FL12

Drag Link Assy.

TAP NO: 44.0341



OEM NO: 1075 664
2 0393 063
MODEL: FH12 FH16
FM12

Center Rod

TAP NO: 44.0342



OEM NO: 1599 175
1613 351
MODEL: FL10 FL12

Drag Link Assy.

TAP NO: 44.0343



OEM NO: 1576 092
1606 283
MODEL: F10 F12
F16

Drag Link Assy.

TAP NO: 44.0344



OEM NO: 2 0393 059
3988 698
MODEL: FH12 FH16
FL4 FM12

Drag Link Assy.

TAP NO: 44.0345



OEM NO: 1610 074
1626 750
MODEL: F10 F12
F16

Drag Link Assy.

TAP NO: 44.0346



OEM NO: 1505 857
1577 080
MODEL: F7 F10
F12 F16
FL7 FL10
FL12

Drag Link Assy.

TAP NO: 44.0347



OEM NO: 1628 636
MODEL: FH12 FH16

Drag Link Assy.

TAP NO: 44.0348



OEM NO: 1610 338
1626 751
MODEL: F10 F12
F16 FL4
FM12

Drag Link Assy.

TAP NO: 44.0349



OEM NO: 1592 939
MODEL: F7 F10
FL12

Trio Rod Assy.

TAP NO: 44.0350



OEM NO: 1612 254
3985 570
MODEL: FH12 FH16
FL4 FM

Drag Link Assy.

TAP NO: 44.0351

OEM NO: 1197 338
MODEL: FL7 FL10
FL12



Drag Link Assy.

TAP NO: 44.0352

OEM NO: 3950 703
MODEL: FL16



Rod End

TAP NO: 44.0353

OEM NO: 1507 823
1698 532
MODEL: FL10 FL12
N10



M30x1.5 RHT

Rod End

TAP NO: 44.0354

OEM NO: 1517 440
1417 444
MODEL: F6 F609
F611 F613
F614 FL4
FL408



M28x1.5 105mm RHT

Rod End

TAP NO: 44.0355

OEM NO: 1695 689
1698 839
MODEL: FL6 FL612
614 615

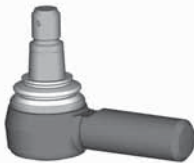

M30x1.5 115mm LHT

Rod End

TAP NO: 44.0356

OEM NO: 1696 920
MODEL: FL4 FL6



M24x1.5 LHT

Rod End

TAP NO: 44.0357

OEM NO: 3092 189
MODEL: FH12 FH16

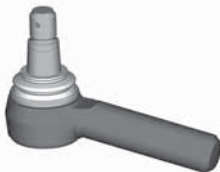

M30x1.5 RHT

Rod End

TAP NO: 44.0358

OEM NO: 1131 742
1696 901
MODEL: FL7 FL10



M52x1.5 LHT

Ball Joint

TAP NO: 44.0359

OEM NO: 275 988
MODEL: F12 FH12
FH16 FL10
FM12



D=Ø67 d=Ø17 Ax=100 H=24

Ball Joint

TAP NO: 44.0360

OEM NO: 274 070
MODEL: F12 FL10



D=Ø75 d=Ø21 Ax=130 H=24

Ball Joint

TAP NO: 44.0361



OEM NO: 3093 462
MODEL: FH12 FH16
NH12 FM9

D=Ø75 d=Ø17 Ax=115 H=24

Ball Joint

TAP NO: 44.0362



OEM NO: 2 0840 815
3093 630
MODEL: FM440
FM480
FM500

Ball Joint

TAP NO: 44.0363



OEM NO: 274 068
MODEL: F12 F
F16 FL10
FL12 FL7

D=Ø85 d=Ø21 Ax=152 H=24

Ball Joint

TAP NO: 44.0364



OEM NO: 273 373
274 019
MODEL: F10 F12
FM12 FL7

D=Ø85 d=Ø21 Ax=130 H=30

Ball Joint

TAP NO: 44.0365



OEM NO: 271 187
MODEL: FH12 FH16
FM12

D=Ø75 d=Ø17 Ax=115 H=24

Ball Joint

TAP NO: 44.0366



OEM NO: 274 056
276 192
MODEL: F10 F12
FL10 FL16

D=Ø95 d=Ø23 Ax=152 H=35

Ball Joint

TAP NO: 44.0367



OEM NO: 2 0547 286

D=Ø75 d=Ø19 Ax=115 H=24

Ball Joint

TAP NO: 44.0368



OEM NO: 273 612
MODEL: F10 F12
F16 FL10
FL12 N10

Repair Kit

TAP NO: 44.0369







OEM NO: 2737 062











Repair Kit

TAP NO: 44.0370













OEM NO: 3133 173

Repair Kit	TAP NO: 44.0371 OEM NO: 2711 885	Repair Kit	TAP NO: 44.0372 OEM NO: 2733 749
			
Repair Kit	TAP NO: 44.0373 OEM NO: 273 375	Repair Kit	TAP NO: 44.0374 OEM NO: 3090 712
			
Repair Kit	TAP NO: 44.0375 OEM NO: 2 0840 820	Repair Kit	TAP NO: 44.0376 OEM NO: 2 0741 710
			
Silicon Hose	TAP NO: 44.0377 OEM NO: 470 464	Silicon Hose	TAP NO: 44.0378 OEM NO: 2 0589 122
	Ø57x65 Flat Green		Ø100x148 F5N Blue
Silicon Hose	TAP NO: 44.0379 OEM NO: 1675 097 1675 579	Silicon Hose	TAP NO: 44.0380 OEM NO: 1660 264 1675 098
	Ø100x148 F5N Black		Ø76x305 M10N Blue

<p>Slicon Hose TAP NO: 44.0381</p> <p>OEM NO: 1675 097 1675 579</p>  <p>Ø76x245 M5N</p>	<p>Slicon Hose TAP NO: 44.0382</p> <p>OEM NO: 1665 556 8149 800</p>  <p>Ø80x390 M9N Blue</p>
<p>Slicon Hose TAP NO: 44.0383</p> <p>OEM NO: 466 328</p>  <p>Ø19x60 Flat Blue</p>	<p>Ball Joint TAP NO: 44.0384</p> <p>OEM NO: 1075 255 1591 689 MODEL: FH12 FL6</p> 
<p>Ball Joint TAP NO: 44.0385</p> <p>OEM NO: 1628 107 MODEL: FH12 FL6</p> 	<p>Cabin Suspansion Air Spring TAP NO: 44.0386</p> <p>OEM NO: 2042 7897 2072 1169 MODEL: F12 F16</p> 
<p>Cabin Suspansion Air Spring TAP NO: 44.0387</p> <p>OEM NO: 1629 719 1629 724 MODEL: FH12 FH16</p> 	<p>Cabin Suspansion Air Spring TAP NO: 44.0388</p> <p>OEM NO: 1075 076 1075 077 MODEL: F12 F16</p> 
<p>Cabin Tilting Pump TAP NO: 44.0389</p> <p>OEM NO: 3943 332 8151 731</p> 	<p>Cabin Tilting Pump TAP NO: 44.0390</p> <p>OEM NO: 1075 295 1095 004</p> 

<p>Cabin Tilting Pump</p> <p>TAP NO: 44.0391</p> <p>OEM NO: 2045 5259 2045 5262</p> 	<p>Cabin Tilting Pump</p> <p>TAP NO: 44.0392</p> <p>OEM NO: 1075 296 1095 005</p> 
<p>Cabin Tilting Cylinder</p> <p>TAP NO: 44.0393</p> <p>REF. NO: 2092 2303 2092 2308</p> 	<p>Cabin Tilting Cylinder</p> <p>TAP NO: 44.0394</p> <p>OEM NO: 2 0922 305</p> 
<p>Cabin Tilting Cylinder</p> <p>TAP NO: 44.0395</p> <p>OEM NO: 1082 068 1571 287</p> 	<p>Cabin Tilting Cylinder</p> <p>TAP NO: 44.0396</p> <p>OEM NO: 1075 233 2 0452 326</p> 
<p>Cabin Latch</p> <p>TAP NO: 44.0397</p> <p>OEM NO: 2 0443 002</p> 	<p>Door Latch Left</p> <p>TAP NO: 44.0398</p> <p>OEM NO: 2 0588 325</p> 
<p>Door Latch Right</p> <p>TAP NO: 44.0399</p> <p>OEM NO: 2 0588 326</p> 	<p>Engine Mounting</p> <p>TAP NO: 44.0400</p> <p>OEM NO: 7030 177</p> 

<p>Engine Mounting</p> <p>TAP NO: 44.0401</p> <p>OEM NO: 1629 614</p> 	<p>Engine Mounting</p> <p>TAP NO: 44.0402</p> <p>OEM NO: 1622 148</p> 
<p>Engine Mounting</p> <p>TAP NO: 44.0403</p> <p>OEM NO: 2 0503 552 MODEL: FH12 FH16 FM10</p> 	<p>Engine Mounting</p> <p>TAP NO: 44.0404</p> <p>OEM NO: 2 0503 550 MODEL: FH12 FH16 FM10</p> 
<p>Engine Mounting</p> <p>TAP NO: 44.0405</p> <p>OEM NO: 2 0503 551 MODEL: FH12 FH16 FM10</p> 	<p>Spring Mounting</p> <p>TAP NO: 44.0406</p> <p>OEM NO: 1629 553 1609 657 MODEL: F7 F10 F12 F16 N10</p> 
<p>Air Spring</p> <p>TAP NO: 44.0407</p> <p>OEM NO: 1134 445 REF NO: 644 N MODEL: F12 FH12 FL6</p> 	<p>Air Spring</p> <p>TAP NO: 44.0408</p> <p>OEM NO: 1137 882 REF NO: 661 N</p> 
<p>Air Spring</p> <p>TAP NO: 44.0409</p> <p>OEM NO: 1611 776 REF NO: 673 N MODEL: F10 FL10</p> 	<p>Air Spring</p> <p>TAP NO: 44.0410</p> <p>OEM NO: 1622 116 REF NO: 720 N MODEL: FL7 FL6 FL10 FH16 FH12</p> 

Air Spring

TAP NO: 44.0411

OEM NO: 6885 533



Air Spring

TAP NO: 44.0412

OEM NO: 1593 842
REF NO: 716 N



Air Spring

TAP NO: 44.0413

OEM NO: 1590 136
MODEL: F10 F12
F16 FL6
FL7 FL10



Air Spring

TAP NO: 44.0414

OEM NO: 1134 446
REF NO: 727 N

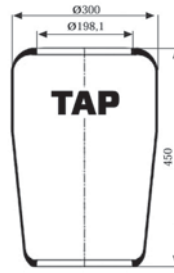

Air Spring

TAP NO: 44.0415

OEM NO: 1612 445



Air Spring

TAP NO: 44.0416

OEM NO: 6782 726
REF NO: 788 N
MODEL: FL 6



Air Spring

TAP NO: 44.0417

OEM NO: 1082 085
REF NO: 883 N1
MODEL: FL10



Air Spring

TAP NO: 44.0418

OEM NO: 3116 354
REF NO: 927 N



Air Spring

TAP NO: 44.0419

OEM NO: 3116 983
REF NO: 928 N



Air Spring

TAP NO: 44.0420

OEM NO: 1075 290
REF NO: 1421 N
MODEL: FM7 FL12
FL7 FH10
FH12



Air Spring

TAP NO: 44.0421

OEM NO: 10753 66



Air Spring

TAP NO: 44.0422

OEM NO: 3027 271
REF NO: RZ 415-25



Air Spring

TAP NO: 44.0423

OEM NO: 3111 277



Air Spring

TAP NO: 44.0424

REF. NO: 1080 707
REF NO: 810 MB
MODEL: F10
F12

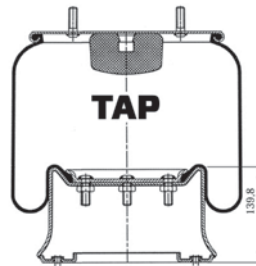

Air Spring

TAP NO: 44.0425

OEM NO: 3027 272
REF NO: RZ 415-28

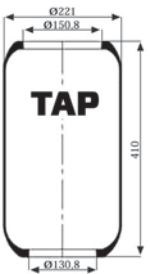

Air Spring

TAP NO: 44.0426

OEM NO: 1076 075

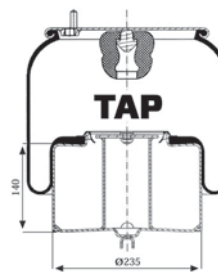

Air Spring

TAP NO: 44.0427

OEM NO: 1076 594
1076 595
REF NO: 4713 N P02
MODEL: NH12 FL7
FL10 FH16
FH12

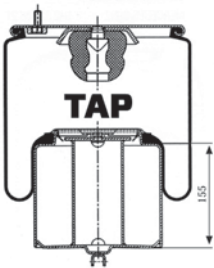

Air Spring

TAP NO: 44.0428

OEM NO: 1075 363
REF NO: 4718 N P01
MODEL: FH12 FM12
FM7

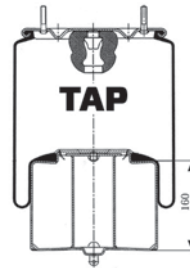

Air Spring

TAP NO: 44.0429

OEM NO: 2 0573 108
REF NO: 6604 N P01

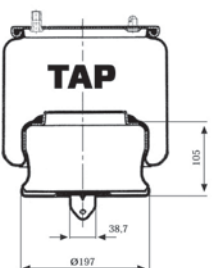

Air Spring

TAP NO: 44.0430

OEM NO: 2 0427 803
MODEL: FM9 FM7
FM12 FL6



Air Spring

TAP NO: 44.0431

OEM NO: 2 0427 804

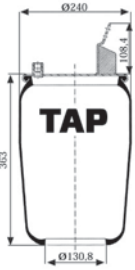

Air Spring

TAP NO: 44.0432

OEM NO: 3171 694

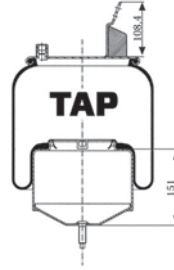

Air Spring

TAP NO: 44.0433

OEM NO: 3171 692
MODEL: FH12 FH16
FM9 FM10

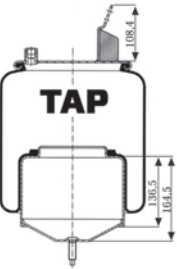

Air Spring

TAP NO: 44.0434

OEM NO: 1076 418

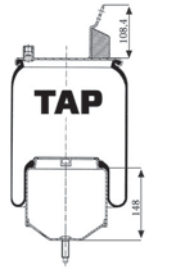

Air Spring

TAP NO: 44.0435

OEM NO: 1076 416

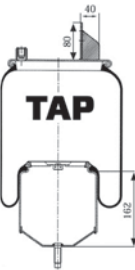

Air Spring

TAP NO: 44.0436

OEM NO: -

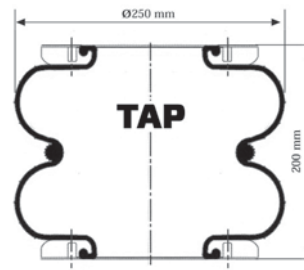

Air Spring

TAP NO: 44.0437

OEM NO: 1076 420



Air Spring

TAP NO: 44.0438

OEM NO: -

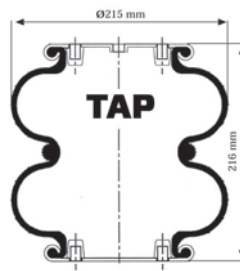

Water Pump

TAP NO: 44.0439

OEM NO: 1545 246



Ø15mm









Water Pump



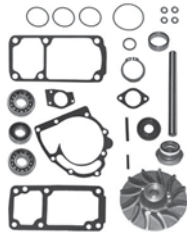







TAP NO: 44.0440









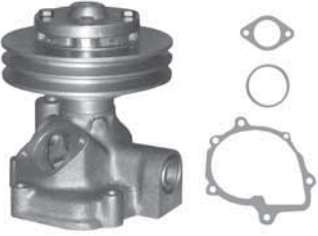

OEM NO: 1545 248



















Ø15mm

<p>Water Pump</p> <p>TAP NO: 44.0441</p> <p>OEM NO: 1699 785</p>  <p>Ø15mm</p>	<p>Water Pump</p> <p>TAP NO: 44.0442</p> <p>OEM NO: 1699 789</p>  <p>Ø15mm</p>
<p>Water Pump</p> <p>TAP NO: 44.0443</p> <p>OEM NO: 1545 261</p> <p>MODEL: F10 F12 FL10 N10</p>  <p>Ø15mm</p>	<p>Repair Kit</p> <p>TAP NO: 44.0444</p> <p>OEM NO: 276 800</p> <p>MODEL: F10 N10</p>  <p>Ø15mm</p>
<p>Water Pump</p> <p>TAP NO: 44.0445</p> <p>OEM NO: 422 791</p> <p>MODEL: F10 F12 FL10 N10</p>  <p>Ø15mm</p>	<p>Repair Kit</p> <p>TAP NO: 44.0446</p> <p>OEM NO: 276 802</p> <p>MODEL: F10 F12 FL10 N10</p> 
<p>Water Pump</p> <p>TAP NO: 44.0447</p> <p>OEM NO: 2 0431 184</p>  <p>Ø15mm</p>	<p>Repair Kit</p> <p>TAP NO: 44.0448</p> <p>OEM NO: 270 791</p> <p>MODEL: F10 F12 FL10 N10</p> 
<p>Water Pump</p> <p>TAP NO: 44.0449</p> <p>OEM NO: 8149 941</p> <p>MODEL: F12 FL12</p>  <p>Ø15mm</p>	<p>Repair Kit</p> <p>TAP NO: 44.0450</p> <p>OEM NO: 276 814</p> <p>MODEL: F10 F12 N10</p> 

<p>Water Pump</p> 	<p>TAP NO: 44.0451</p> <p>OEM NO: 8170 305 MODEL: FH12 FM12 NH12</p> <p>Ø15mm</p>	<p>Repair Kit</p> 	<p>TAP NO: 44.0452</p> <p>OEM NO: 276 121</p>
<p>Water Pump</p> 	<p>TAP NO: 44.0453</p> <p>OEM NO: 8149 980</p> <p>Ø15mm</p>	<p>Repair Kit</p> 	<p>TAP NO: 44.0454</p> <p>OEM NO: 276 637</p>
<p>Water Pump</p> 	<p>TAP NO: 44.0455</p> <p>OEM NO: 8192 050 MODEL: FL6 FL7</p> <p>Ø15mm</p>	<p>Repair Kit</p> 	<p>TAP NO: 44.0456</p> <p>OEM NO: 276 942 MODEL: FL6 FL7 FS7</p>
<p>Water Pump</p> 	<p>TAP NO: 44.0457</p> <p>OEM NO: 2 0744 939 MODEL: FM500 FM480 FM340 FH540-400 420-440</p>	<p>Water Pump</p> 	<p>TAP NO: 44.0458</p> <p>OEM NO: 2 0411 880</p>
<p>Water Pump</p> 	<p>TAP NO: 44.0459</p> <p>OEM NO: 1699 784</p> <p>Ø15mm</p>	<p>Repair Kit</p> 	<p>TAP NO: 44.0460</p> <p>OEM NO: 276 806</p> <p>Ø15mm</p>

<p>Water Pump</p> <p>TAP NO: 44.0461</p> <p>OEM NO: 466 088</p>  <p>Ø15mm</p>	<p>Water Pump</p> <p>TAP NO: 44.0462</p> <p>OEM NO: 465 242</p>  <p>Ø15mm</p>
<p>Water Pump</p> <p>TAP NO: 44.0463</p> <p>OEM NO: 1699 783</p>  <p>Ø15mm</p>	<p>Water Pump</p> <p>TAP NO: 44.0464</p> <p>OEM NO: 8149 882 MODEL: FH12 FL12</p>  <p>Ø15mm</p>
<p>Repair Kit</p> <p>TAP NO: 44.0465</p> <p>OEM NO: 276 852</p> 	<p>Water Pump</p> <p>TAP NO: 44.0466</p> <p>OEM NO: 2 0431 135 MODEL: FH12 FM12 NH12</p>  <p>Ø15mm</p>
<p>Repair Kit</p> <p>TAP NO: 44.0467</p> <p>OEM NO: -</p> 	<p>Water Pump</p> <p>TAP NO: 44.0468</p> <p>OEM NO: 2 0575 653 MODEL: FM7 FL6</p>  <p>Ø15mm</p>
<p>Repair Kit</p> <p>TAP NO: 44.0469</p> <p>OEM NO: 276 943</p> 	<p>Impeller</p> <p>TAP NO: 44.0470</p> <p>OEM NO: 468 244</p>  <p>120x15mm</p>

<p>Impeller</p> <p>TAP NO: 44.0471</p> <p>OEM NO: 1675 944</p>  <p>120x19mm</p>	<p>Impeller</p> <p>TAP NO: 44.0472</p> <p>OEM NO: 3183 676</p>  <p>120x15mm</p>
<p>Impeller</p> <p>TAP NO: 44.0473</p> <p>OEM NO: 8121 826</p>  <p>120x15mm</p>	<p>Impeller</p> <p>TAP NO: 44.0474</p> <p>OEM NO: 2 0587 287</p>  <p>117x15mm</p>
<p>Impeller</p> <p>TAP NO: 44.0475</p> <p>OEM NO: 1676 714</p>  <p>120x15mm</p>	<p>Impeller</p> <p>TAP NO: 44.0476</p> <p>OEM NO: 2 0431 128</p>  <p>130x15mm</p>
<p>Impeller</p> <p>TAP NO: 44.0477</p> <p>OEM NO: 3183 685</p>  <p>117x15mm</p>	<p>Shaft</p> <p>TAP NO: 44.0478</p> <p>OEM NO: 421 549</p>  <p>Ø15mm</p>
<p>Shaft</p> <p>TAP NO: 44.0479</p> <p>OEM NO: 3184 813</p>  <p>Ø19mm</p>	<p>Shaft</p> <p>TAP NO: 44.0480</p> <p>OEM NO: 468 249</p>  <p>Ø15mm</p>

<p>Shaft</p> <p>TAP NO: 44.0481</p> <p>OEM NO: 421 148</p>  <p>Ø15mm</p>	<p>Shaft</p> <p>TAP NO: 44.0482</p> <p>OEM NO: 422 148</p>  <p>Ø15mm</p>
<p>Slide Ring Seal</p> <p>TAP NO: 44.0483</p> <p>OEM NO: 1676 432</p>  <p>36,50x15,00mm</p>	<p>Slide Ring Seal</p> <p>TAP NO: 44.0484</p> <p>OEM NO: 1676 561</p>  <p>40,00x19,00mm</p>
<p>Gear</p> <p>TAP NO: 44.0485</p> <p>REF. NO: 470 265</p>  <p>58,5x30mm</p>	<p>Gear</p> <p>TAP NO: 44.0486</p> <p>OEM NO: 1457 483</p>  <p>63,5x30mm</p>
<p>Gear</p> <p>TAP NO: 44.0487</p> <p>OEM NO: 471 501</p>  <p>67,5x30mm</p>	<p>Bearing</p> <p>TAP NO: 44.0488</p> <p>OEM NO: 471 499</p>  <p>60x30mm</p>
<p>Bearing</p> <p>TAP NO: 44.0489</p> <p>OEM NO: 8170 308</p>  <p>55x15mm</p>	<p>King Pin Set</p> <p>TAP NO: 44.0490</p> <p>REF. NO: -</p> 

King Pin Set

TAP NO: 44.0491

OEM NO: 276 029
276 014
MODEL: N10



King Pin Set

TAP NO: 44.0492

REF. NO: 276 193
6782 631
MODEL: FL6



King Pin Set

TAP NO: 44.0493

REF. NO: 3090 266
271 142
MODEL: NH12 N10
FM7 FM12



Pump

TAP NO: 44.0494

OEM NO: 364 642



100 BAR

Pump

TAP NO: 44.0495

OEM NO: 1589 925
5001 933



135 BAR

Pump

TAP NO: 44.0496

OEM NO: 1585 013



135 BAR

Pump

TAP NO: 44.0497

OEM NO: 1587 787
5001 938



120 BAR

Pump

TAP NO: 44.0498

REF. NO: 1589 231



135 BAR

Radiator Hose

TAP NO: 44.0499

OEM NO: 475 861
MODEL: F10



60x60x480











Radiator Hose





TAP NO: 44.0500









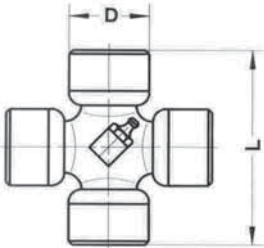
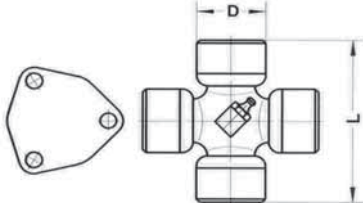
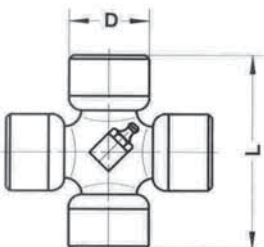
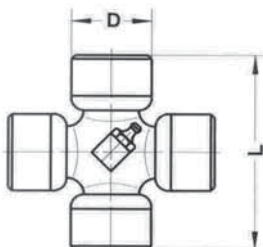
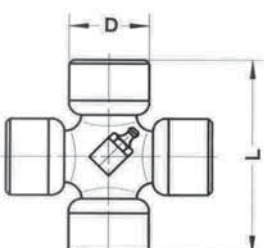
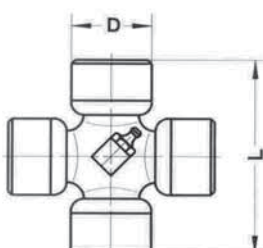

OEM NO: 475 900
MODEL: F10



60x65x510









Radiator Hose	TAP NO: 44.0501	Radiator Hose	TAP NO: 44.0502
	OEM NO: 476 503 MODEL: F10 20x20x300		OEM NO: 1544 845 MODEL: F10 55x59x320
Radiator Hose	TAP NO: 44.0503	Radiator Hose	TAP NO: 44.0504
	OEM NO: 1664 045 MODEL: FH12 FH16 30x38x205		OEM NO: 1665 951 MODEL: FH12 60x60x480
Radiator Hose	TAP NO: 44.0505	Radiator Hose	TAP NO: 44.0506
	OEM NO: 3154 395 MODEL: F12 20x20x310		OEM NO: 2 0367 063 MODEL: F FH12 12x12x80
Radiator Hose	TAP NO: 44.0507	Radiator Hose	TAP NO: 44.0508
	OEM NO: 2 0453 672 MODEL: F12 20x20x890		OEM NO: 2 0456 429 MODEL: FH 12 FM 13x13x150
Radiator Hose	TAP NO: 44.0509	Radiator Hose	TAP NO: 44.0510
	OEM NO: 2 0542 199 MODEL: FH12 FM12 58x63x520		OEM NO: 2 0542 202 MODEL: FH12 FM 58x61x500











<p>Radiator Hose</p> <p>TAP NO: 44.0511</p> <p>OEM NO: 20542 204 MODEL: FH12</p>  <p>20x20x290</p>	<p>Oil Reservoir and Pump Hose</p> <p>TAP NO: 44.0512</p> <p>OEM NO: 2 0544 321 MODEL: FH12</p>  <p>21x21x340</p>
<p>Radiator Hose</p> <p>TAP NO: 44.0513</p> <p>OEM NO: 2 0968 736 MODEL: FH16</p>  <p>58x61x440</p>	<p>Radiator Hose</p> <p>TAP NO: 44.0514</p> <p>OEM NO: 20968 744 MODEL: FH16</p>  <p>58x61x440</p>
<p>Universal Joint</p> <p>TAP NO: 44.0515</p> <p>OEM NO: 232 458</p>  <p>44x126mm</p>	<p>Universal Joint</p> <p>TAP NO: 44.0516</p> <p>OEM NO: 1651 032</p>  <p>50x152,60mm</p>
<p>Universal Joint</p> <p>TAP NO: 44.0517</p> <p>OEM NO: 232 362</p>  <p>52x133mm</p>	<p>Universal Joint</p> <p>TAP NO: 44.0518</p> <p>OEM NO: 1068 247</p>  <p>52x147,20mm</p>
<p>Universal Joint</p> <p>TAP NO: 44.0519</p> <p>OEM NO: 1 0672 931</p>  <p>57x152mm</p>	<p>Universal Joint</p> <p>TAP NO: 44.0520</p> <p>OEM NO: 232 540</p>  <p>57x144mm</p>









<p>Fan Blade</p> <p>TAP NO: 44.0521</p> <p>OEM NO: 2 041 653 3</p> 	<p>Fan Blade</p> <p>TAP NO: 44.0522</p> <p>OEM NO: 1674 865 1674 189 3979 918 8112 952</p> <p>MODEL: FH 12 FH16 NH 12</p> 
<p>Fan Blade</p> <p>TAP NO: 44.0523</p> <p>OEM NO: 2051 7745 2080 5992 2098 1224</p> <p>MODEL: FH 12 FM 10 FL 10 FM 12</p> 	<p>Fan Blade</p> <p>TAP NO: 44.0524</p> <p>OEM NO: 2 045 023 9 2 039 761 8</p> <p>MODEL: FM 9 FM 12</p> 
<p>Fan Blade</p> <p>TAP NO: 44.0525</p> <p>OEM NO: 703 0 7114</p> <p>MODEL: B 12</p> 	<p>Starter Motor</p> <p>TAP NO: 44.0526</p> <p>OEM NO: 1697 220</p> 
<p>Starter Motor</p> <p>TAP NO: 44.0527</p> <p>OEM NO: 240 488</p> <p>MODEL: F10 F12 FL7 FM7</p> 	<p>Starter Motor</p> <p>TAP NO: 44.0528</p> <p>OEM NO: 240 636</p> 
<p>Starter Motor</p> <p>TAP NO: 44.0529</p> <p>OEM NO: 244 539</p> 	<p>Starter Motor</p> <p>TAP NO: 44.0530</p> <p>OEM NO: 1697 220</p> 

<p>Starter Motor</p> <p>TAP NO: 44.0531</p> <p>OEM NO: 3099 582</p> 	<p>Starter Motor</p> <p>TAP NO: 44.0532</p> <p>OEM NO: 6212 614</p> 
<p>Starter Motor</p> <p>TAP NO: 44.0533</p> <p>OEM NO: 6643 732</p> 	<p>Starter Motor</p> <p>TAP NO: 44.0534</p> <p>OEM NO: 2 0409 228</p> <p>MODEL: FM12 FH12</p> <p>9700 9900</p> 
<p>Starter Motor</p> <p>TAP NO: 44.0535</p> <p>OEM NO: 2 0466 315</p> 	<p>Control Wire</p> <p>TAP NO: 44.0536</p> <p>OEM NO: 3176 136</p> 
<p>Control Wire</p> <p>TAP NO: 44.0537</p> <p>OEM NO: 1613 336</p> 	<p>Control Wire</p> <p>TAP NO: 44.0538</p> <p>OEM NO: 1622 577</p> 
<p>Control Wire</p> <p>TAP NO: 44.0539</p> <p>OEM NO: 8191 136</p> 	<p>Electrical Coils</p> <p>TAP NO: 44.0540</p> <p>OEM NO: -</p> <p>24 Volt 5-pole</p> 





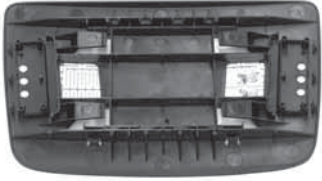



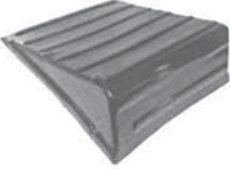

Electrical Coils	TAP NO: 44.0541	Electrical Coils	TAP NO: 44.0542
	OEM NO: -		OEM NO: -
	24 Volt 7-pole		24 Volt 15-pole
Plug	TAP NO: 44.0543	Socket	TAP NO: 44.0544
	OEM NO: -		OEM NO: -
	5 Pin / ABS / 24 Volt 7 Pin / EBS / 24 Volt 15 Pin / PLUG / 24 Volt		5 Pin / ABS / 24 Volt 7 Pin / EBS / 24 Volt 15 Pin / Socket / 24 Volt
Headlight W/Emboss Lens	TAP NO: 44.0545	Headlight	TAP NO: 44.0546
	OEM NO: - MODEL: F10-F12		OEM NO: - MODEL: F10-F12- F16 (400Power) (1985-1990)
			
Headlight	TAP NO: 44.0547	Headlight	TAP NO: 44.0548
	OEM NO: - MODEL: FH12-FH16 Version I (1993-2001)		OEM NO: - MODEL: FH16 (2003→)
			
Headlight	TAP NO: 44.0549	Tail Lamp	TAP NO: 44.0550
	OEM NO: - MODEL: FL-NL10/240		OEM NO: - MODEL: FH-FL-FM
			

<p>Tail Lamp</p> 	<p>TAP NO: 44.0551</p> <p>OEM NO: 2050 7623 MODEL: FE-FL</p>	<p>Corner Lamp</p> 	<p>TAP NO: 44.0552</p> <p>OEM NO: 1593 923 / L 1593 924 / R MODEL: F10-12</p>
<p>Headlight</p> 	<p>TAP NO: 44.0553</p> <p>OEM NO: 2040 9874 / L 2040 9875 / R MODEL: FH16 (2003→) Version II</p>	<p>Corner Lamp</p> 	<p>TAP NO: 44.0554</p> <p>REF. NO: MODEL: FL-NL10/240</p>
<p>Front Indicator</p> 	<p>TAP NO: 44.0555</p> <p>OEM NO: - MODEL: FH-FM (FH16)</p>	<p>Tail Lamp</p> 	<p>TAP NO: 44.0556</p> <p>OEM NO: 2056 5103 MODEL: FH-FM</p>
<p>Tail Lamp</p> 	<p>TAP NO: 44.0557</p> <p>OEM NO: 1620 478 MODEL: F-FL-FLC-FS</p>	<p>Tail Lamp</p> 	<p>TAP NO: 44.0558</p> <p>REF. NO: MODEL: 1F-FL</p>
<p>Top Marker Lamp</p> 	<p>TAP NO: 44.0559</p> <p>OEM NO: - MODEL: FH-FL (FH12)</p>	<p>Indicator & Position Lamp</p> 	<p>TAP NO: 44.0560</p> <p>OEM NO: 3981 668 MODEL: FH-FL-FM</p>

<p>Indicator Lamp</p> 	<p>TAP NO: 44.0561</p> <p>OEM NO: 8191 145 MODEL: FH-FL-FM</p>	<p>Position Lamp</p> 	<p>TAP NO: 44.0562</p> <p>OEM NO: 3981 666 MODEL: 1FH-FL (F10-12-16)</p>
<p>Corner Lamp</p> 	<p>TAP NO: 44.0563</p> <p>OEM NO: - MODEL: F10</p>	<p>Side Marker Lamp</p> 	<p>TAP NO: 44.0564</p> <p>OEM NO: - MODEL: FH-FM-FL</p>
<p>Front Indicator</p> 	<p>TAP NO: 44.0565</p> <p>OEM NO: - MODEL: FH (FH13)</p>	<p>Fog Lamp Frame</p> 	<p>TAP NO: 44.0566</p> <p>OEM NO: - MODEL: FH (FH13)</p>
<p>Fog Lamp</p> 	<p>TAP NO: 44.0567</p> <p>OEM NO: - MODEL: FH (FH13)</p>	<p>Fog Lamp</p> 	<p>TAP NO: 44.0568</p> <p>OEM NO: - MODEL: FH (FH13)</p>
<p>Mirror</p> 	<p>TAP NO: 44.0569</p> <p>OEM NO: 2 0455 986 2 0567 670 MODEL: FH II FM II 04/02</p> <p>435x200mm</p>	<p>Mirror</p> 	<p>TAP NO: 44.0570</p> <p>OEM NO: - MODEL: FH II FM II 04/02-03/07</p> <p>290x170mm</p>

<p>Mirror</p> <p>TAP NO: 44.0571</p> <p>OEM NO: - MODEL: FH II FM II 04/02-05/07</p>  <p>690x260mm</p>	<p>Mirror</p> <p>TAP NO: 44.0572</p> <p>OEM NO: - MODEL: FH II FM II 04/02-05/07</p>  <p>690x260mm</p>
<p>Mirror</p> <p>TAP NO: 44.0573</p> <p>OEM NO: 2036 0811 MODEL: FH II FM II 04/02-05/07</p>  <p>235x200mm</p>	<p>Mirror</p> <p>TAP NO: 44.0574</p> <p>OEM NO: -</p>  <p>235x200mm</p>
<p>Mirror</p> <p>TAP NO: 44.0575</p> <p>OEM NO: 2074 6401 MODEL: FH II FM II 04/02-05/07</p> 	<p>Mirror</p> <p>TAP NO: 44.0576</p> <p>OEM NO: -</p>  <p>235x200mm</p>
<p>Mirror</p> <p>TAP NO: 44.0577</p> <p>OEM NO: - MODEL: FH</p>  <p>315x185mm</p>	<p>Mirror</p> <p>TAP NO: 44.0578</p> <p>OEM NO: 2 0862 795 MODEL: FL+FE 09/2006 LH+LE 09/2006</p>  <p>337x202mm</p>
<p>Mirror</p> <p>TAP NO: 44.0579</p> <p>OEM NO: 2086 2810</p>  <p>200x197mm</p>	<p>Sun Visor</p> <p>TAP NO: 44.0580</p> <p>OEM NO: 1599 652</p> 

<p>Sun Visor</p> <p>TAP NO: 44.0581</p> <p>OEM NO: 8189 318</p> 	<p>Sun Visor</p> <p>TAP NO: 44.0582</p> <p>OEM NO: 8189 319</p> 
<p>Sun Visor</p> <p>TAP NO: 44.0583</p> <p>OEM NO: 8189 320</p> 	<p>Sun Visor</p> <p>TAP NO: 44.0584</p> <p>OEM NO: 8189 321</p> 
<p>Sun Visor</p> <p>TAP NO: 44.0585</p> <p>OEM NO: 8189 310</p> 	<p>Sun Visor</p> <p>TAP NO: 44.0586</p> <p>OEM NO: 8189314 1619 093</p> 
<p>Sun Visor</p> <p>TAP NO: 44.0587</p> <p>OEM NO: 1188 626</p> 	<p>Sun Visor, Mounting</p> <p>TAP NO: 44.0588</p> <p>OEM NO: 1584 306 1584 307</p> 
<p>Battery Box Cover</p> <p>TAP NO: 44.0589</p> <p>OEM NO: 1587 694</p> 	<p>Battery Box Cover</p> <p>TAP NO: 44.0590</p> <p>OEM NO: 1590 507</p> 

<p>Battery Box Cover</p> <p>TAP NO: 44.0591</p> <p>OEM NO: 3127 594</p> 	<p>Piston Pump</p> <p>TAP NO: 44.0592</p> <p>OEM NO: -</p>  <p>9 Piston Pumps 80 Lt.</p>
<p>Piston Pump</p> <p>TAP NO: 44.0593</p> <p>OEM NO: -</p>  <p>6 Piston Pumps 50 Lt.</p>	<p>Piston Pump</p> <p>TAP NO: 44.0594</p> <p>OEM NO: -</p>  <p>Performance Serial 9 Piston Pumps 80 Lt.</p>
<p>Piston Pump</p> <p>TAP NO: 44.0595</p> <p>OEM NO: -</p>  <p>Performance Serial 9 Piston Pumps 80 Lt.</p>	<p>Gear Pump</p> <p>TAP NO: 44.0596</p> <p>OEM NO: -</p>  <p>25 Serial ISO</p>
<p>Gear Pump</p> <p>TAP NO: 44.0597</p> <p>OEM NO: -</p>  <p>25 Serial UNI</p>	<p>Gear Pump</p> <p>TAP NO: 44.0598</p> <p>OEM NO: -</p>  <p>25 Serial T2</p>
<p>Power Take Off</p> <p>TAP NO: 44.0599</p> <p>OEM NO: -</p>  <p>Pump Extension Short Casting</p>	<p>Power Take Off</p> <p>TAP NO: 44.0600</p> <p>OEM NO: -</p>  <p>Pump Extension Long Casting</p>

Hydraulic Valve

TAP NO: **44.0601**

OEM NO: -



Hydraulic Valve

TAP NO: **44.0602**

OEM NO: -



Dumper Control

TAP NO: **44.0603**

OEM NO: -



Swich 2 Way

Dumper Control

TAP NO: **44.0604**

OEM NO: -



Swich 3 Way

Automatic Joystick

TAP NO: **44.0605**

OEM NO: -



2 Way

Automatic Joystick

TAP NO: **44.0606**

OEM NO: -



2 Way

NOTES

A large area of the page is filled with horizontal dotted lines, intended for writing notes.